

**ENDEAVOS Innovations Inc.**

Engineering Design Analysis Validation Optimization Simulation

# Advanced Engineering & Technology Consulting Firm

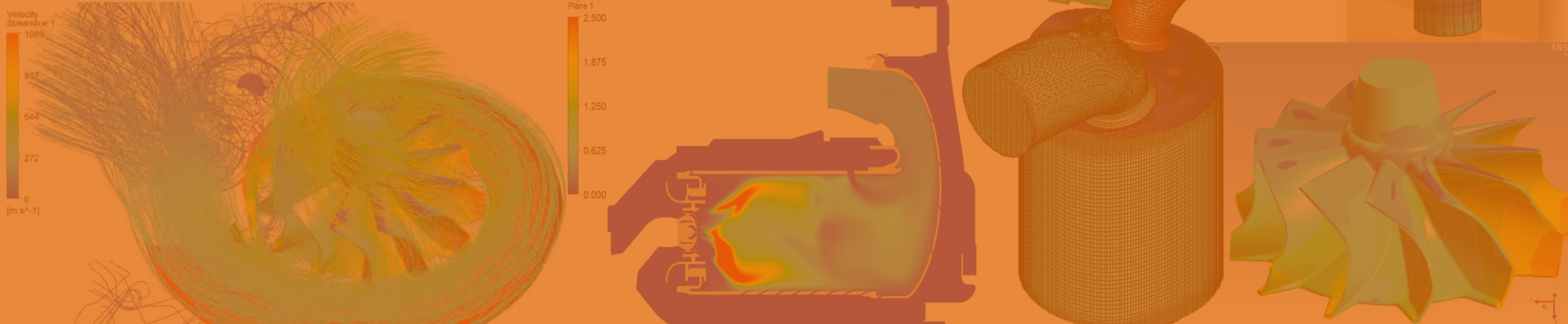

# Company Overview & Services

*Endeavos Innovations is a comprehensive product development, research and engineering services company. Our core philosophy is creativity through collaboration. We work with startups, academia and large companies as part of their team to help innovation through engineering. We utilize state of the art methods and tools combined with years of experience to move an initial idea through various phases of technology development to market in the least amount of time and cost. Our services can also be employed at any phase of development or for any engineering or consulting need.*



**ENDEAVOS**  
**Innovations Inc.**

- Clifton Park, New York, USA.
- Established 2014.
- Technology Development & Engineering.



**Clifton Park, NY Office**

**Design**

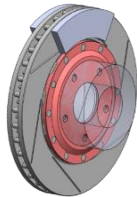

**Analysis (CAE)**

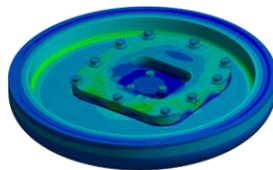

**System Modeling**

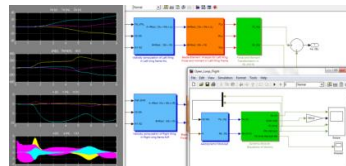

**Test Rigs & Testing**

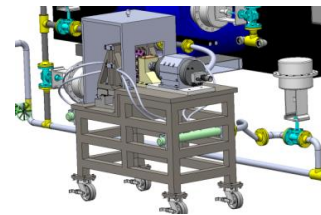

# Engineering Team

## Dr. Zaeem Khan, Ph.D, (Founder & President)

Dr. Khan is responsible for managing the operations of Endeavos Innovations Inc. He has over 22 years experience performing and supervising engineering analysis. He has previously held R&D position at GE Global Research where he worked on a variety of engineering projects ranging from bio-medical devices to wind turbines. His expertise includes: modeling and simulation of structures and dynamical systems involving Multiphysics (aero, structural, & thermal), design optimization, finite element analysis, conceptual and detailed design.



## Yahya Doğu, Ph.D. (Principal CFD Consultant)

Dr. Yahya Doğu has over 20 years of experience in design and analysis of industrial applications of thermal-fluid systems and has been involved in many R&D projects. His expertise is built on fundamental sciences of fluid mechanics, heat transfer and thermodynamics and validating that with CFD simulations. His experience involves many specific areas: sealing in turbo machinery (brush seal, labyrinth seal, honeycomb seal, cloth seal), flow in porous media, water turbines, solar collectors, optical fiber drawing process, thermal analysis of metal cutting process, 3-D in-cylinder combustion modeling for internal combustion engine, heat exchangers, etc. He has filed two patents on brush seals at GE-CRD and authored many journal and conference papers.



## Dr. Murat Ozmusul, Ph.D, (Principal Consultant)

Dr. Murat is a principal consultant. He is a mechanical engineer with more than 23 years of experience in the R&D industry. His expertise is in brush seals, steam turbines and mechanical design of test rigs. He was formerly a co-founder of SDM research and engineering based in Turkey and the founder of Pro-Solutions US engineering company. He has several high profile projects under his belt including multiple patents.



## Gerald Reidenbaugh, (Mechanical Design Engineer)

Jay Reidenbaugh has over 26 years of mechanical design and manufacturing experience. He has expertise in new concept development, design, analysis, project management, scheduling, estimating, simulation and optimization. He is a great team player with excellent problem-solving, time management, and organizational abilities when faced with complex multi-disciplinary engineering projects.



# How We Do it...

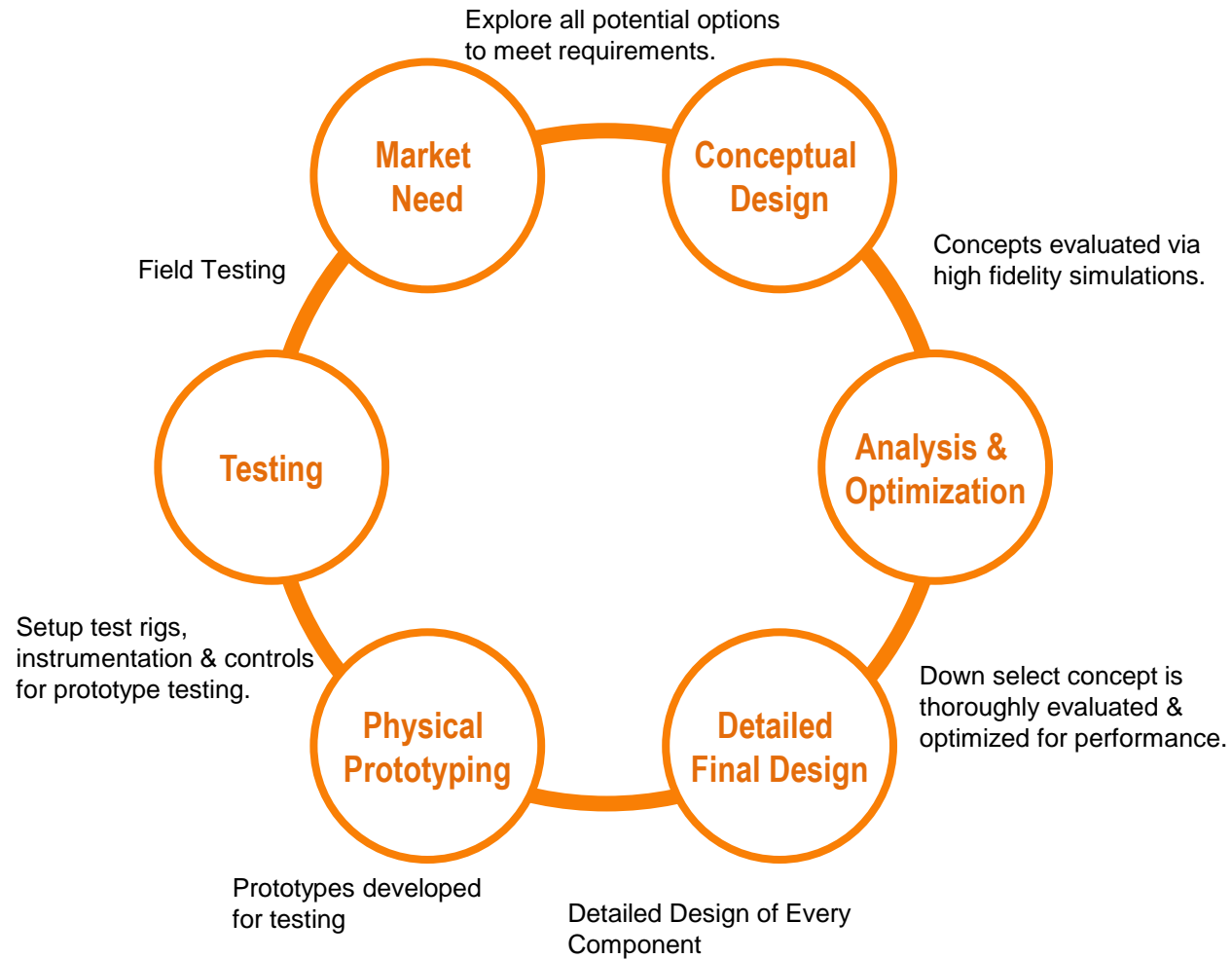

## Results & Benefits

- One stop resource for all mechanical engineering services
- State of the art CAE tools & engineering expertise.
- Expertise is provided when needed. This cuts overhead costs.
- Low rates for pre-seed, seed and early stage startups.
- Valuable resource on standby for established companies.





# Engineering Design

- Engineering design involves conceptual design based on simple first order engineering calculations. This process enables initial material selection, size and performance estimation.
- Based on this CAD (computer aid design) of initial concept is generated.
- This service also includes generation of engineering drawings for machining from provided CAD models as well as creation of CAD models from engineering drawings.
- Physical models are created using rapid prototyping tools such as 3D printing, desktop CNC machining as well as laser cut cardboard and foam.

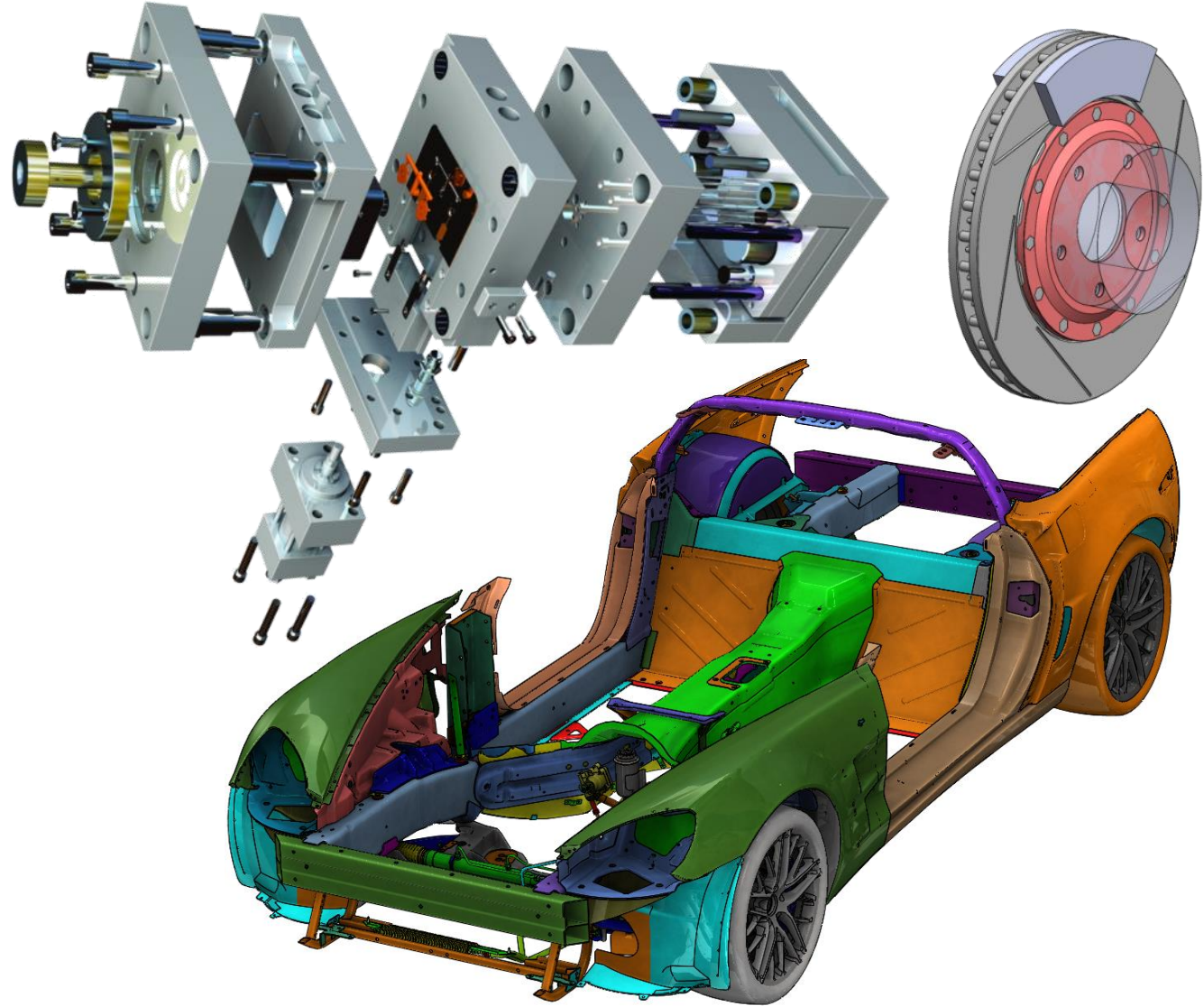

# Computer Aided Engineering (CAE)

Advanced simulations based on numerical computations such as finite element method (FEM) and computational fluid dynamics (CFD) is an essential part of product development process and detailed analysis of existing designs. This capability enables virtual prototyping and testing which significantly cuts down product development time and material cost.

- Structural stress (Elastic/Plastic)
- Joints: Bolted, Adhesive (bonded), Welded, Riveted.
- Nonlinear Plasticity & Buckling.
- Fatigue Analysis
- Dynamics: Transient, Rigid Body, Explicit.
- Mechanical Vibrations (Modal, Harmonic, and Random Vibration Analysis).
- Rotor Dynamics.
- Composite Structures.

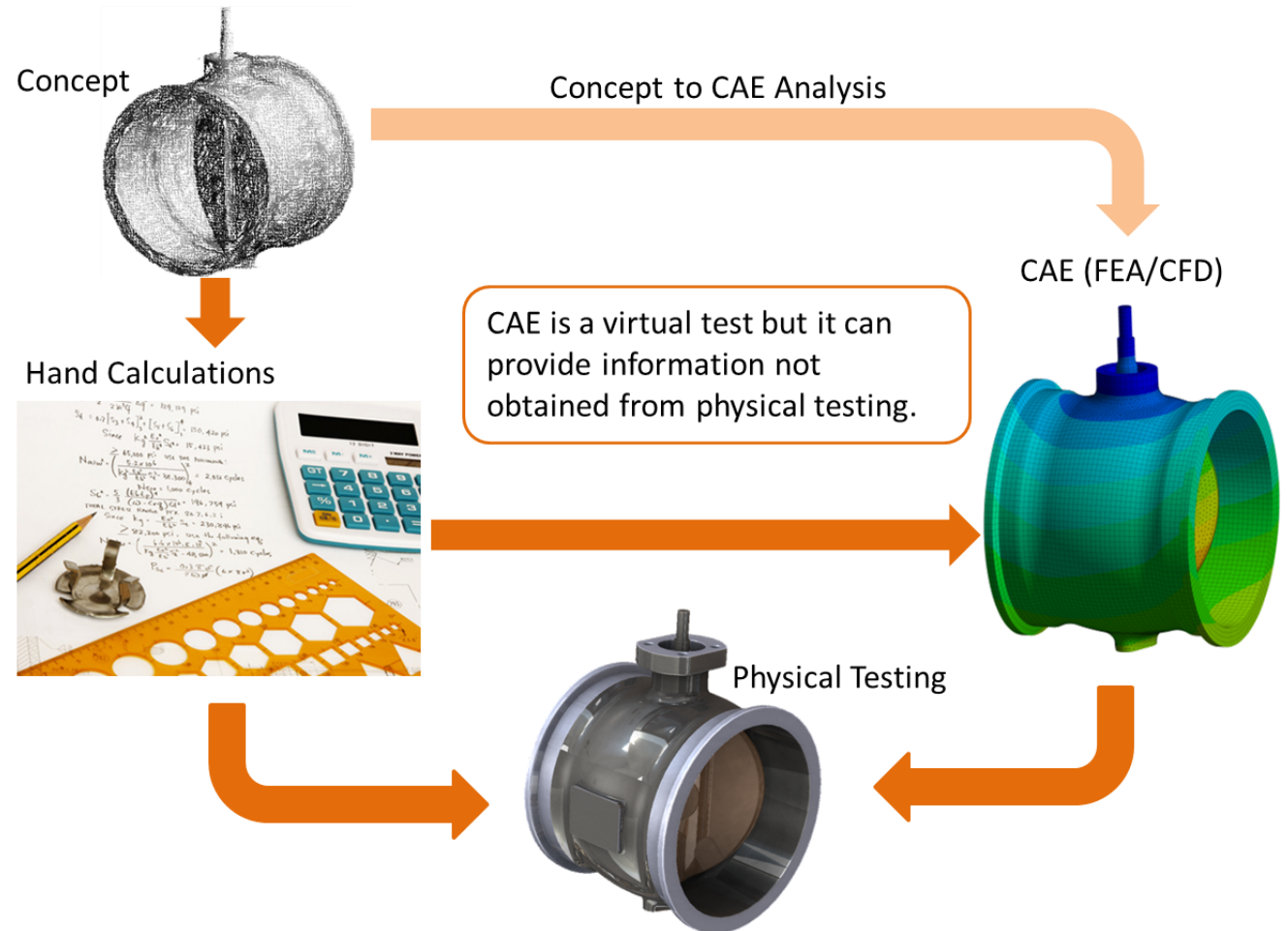

# Finite Element Analysis (FEA)

- Structural Analysis (Elastic/Plastic)
- Nonlinear Plasticity & Buckling.
- Fatigue Analysis.

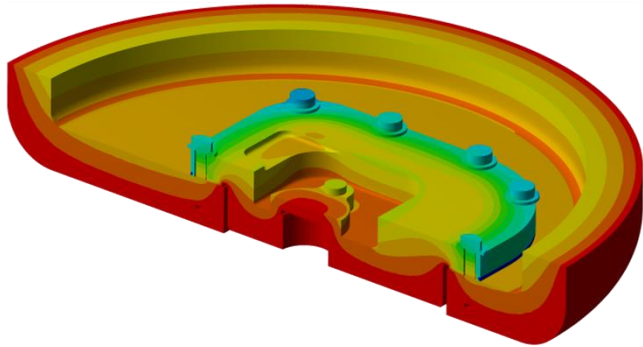

- Steady-State & Transient Thermal Analysis.
- Coupled Thermal & Structural Analysis

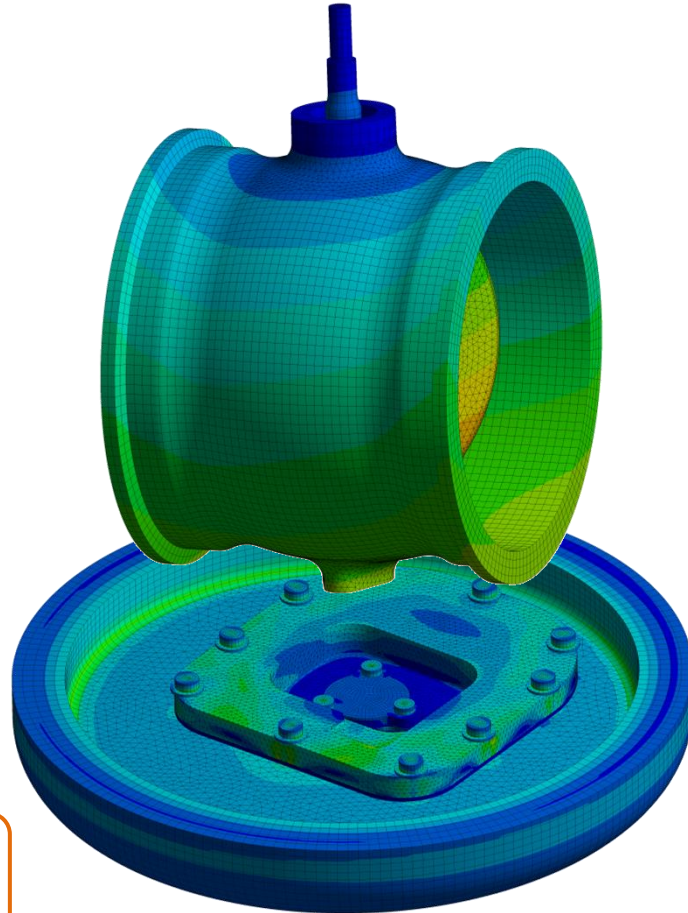

Gasket Analysis



Seal & Leakage Analysis

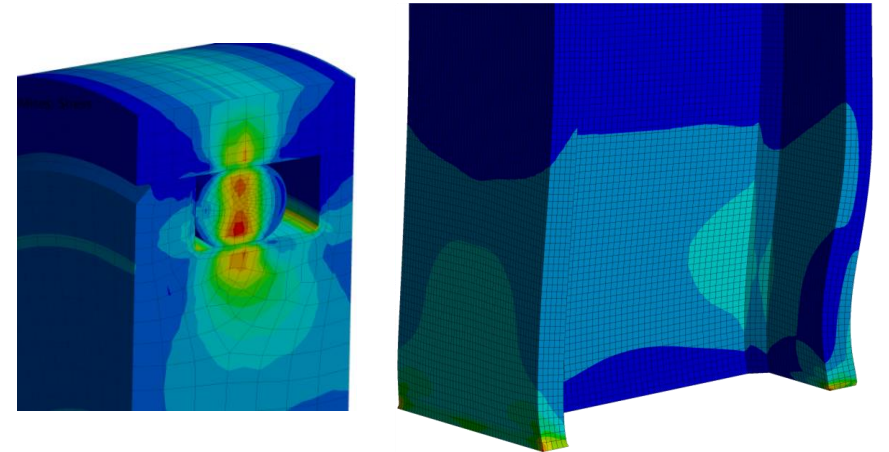



# Mechanical Connections Analysis

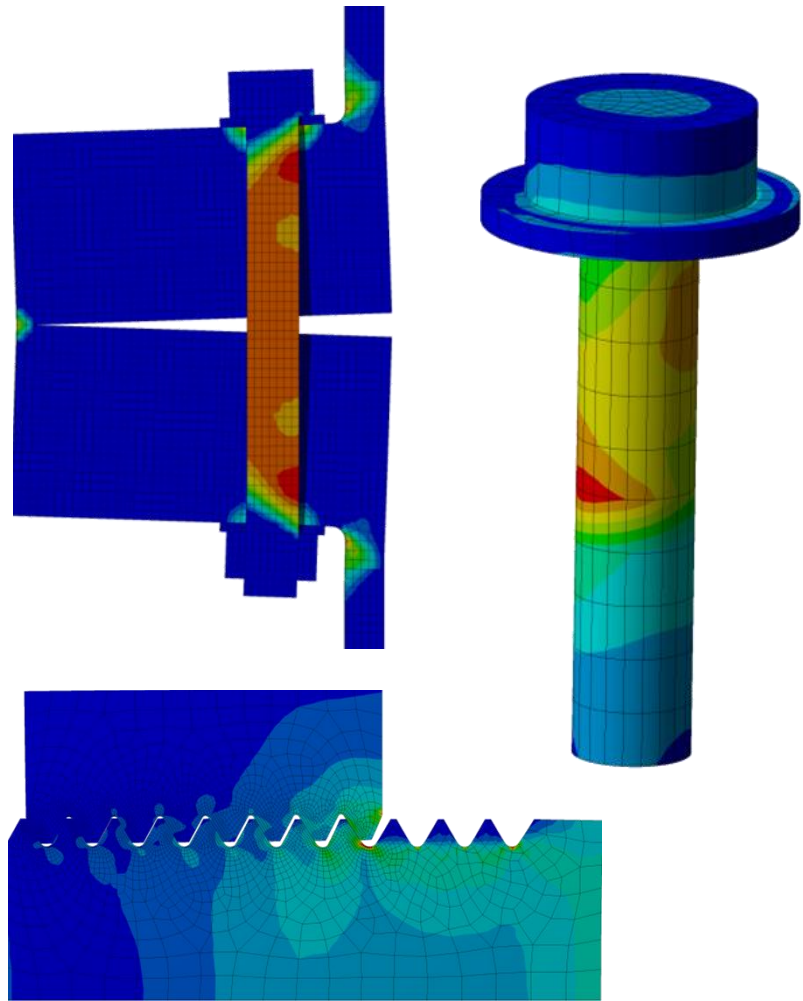

Joints: Bolted, Adhesive (bonded), Welded, Riveted.

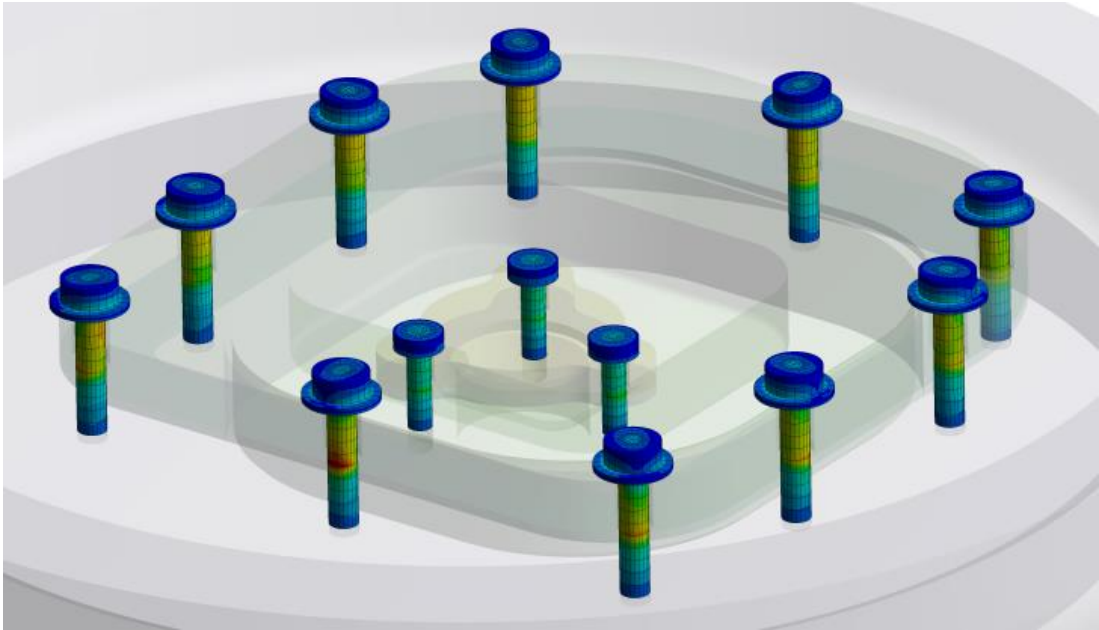



# Structural Topology Optimization

We have the capability to optimize structural designs to reduce mass, deflections as well as change structural stiffness to improve mechanical vibration behavior. Various tools and methods are utilized such as topology and shape optimization. Additionally, any aspect of thermal-structural performance can also be optimized.

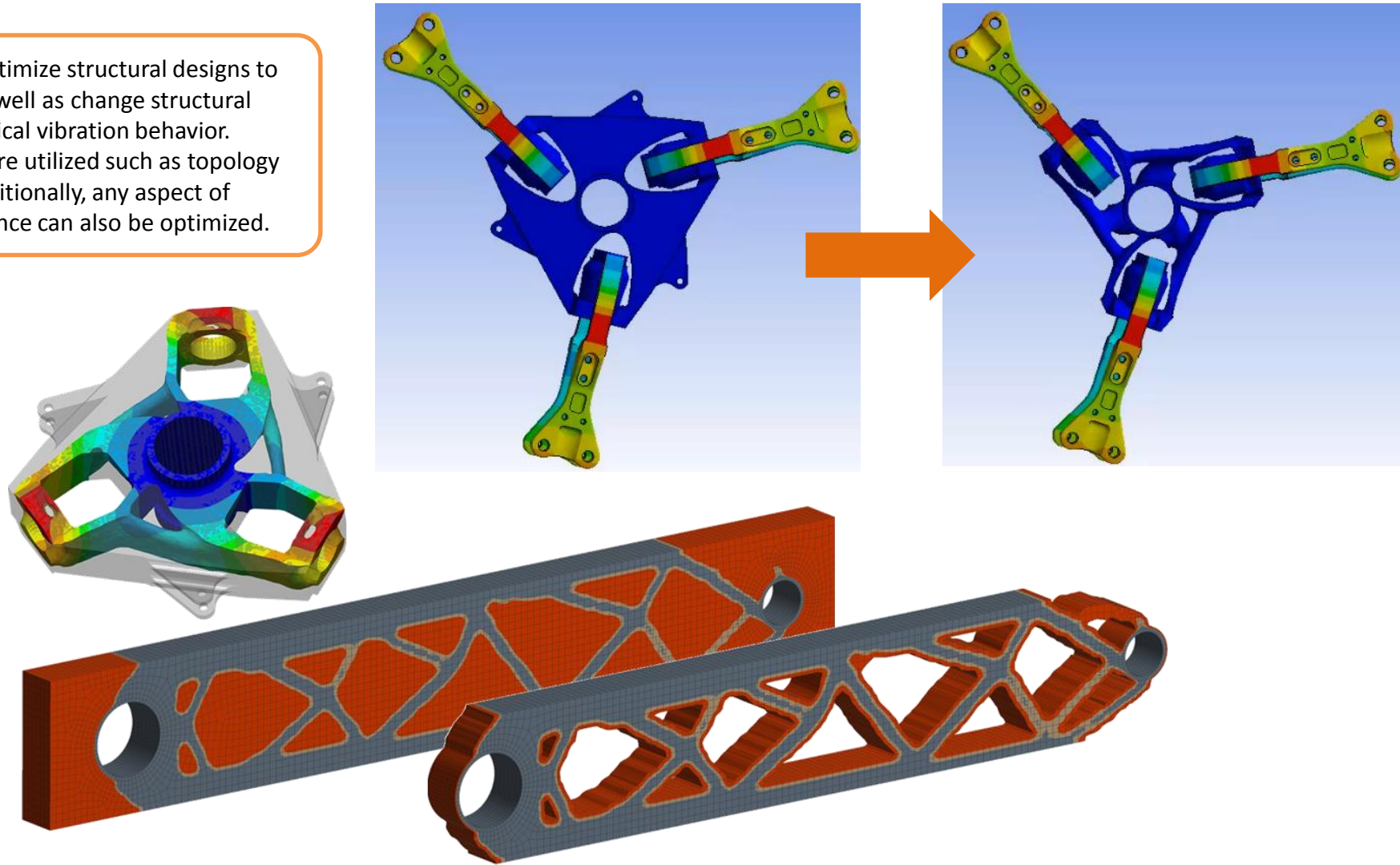

# Rigid-Body & Structural Dynamics

- Dynamics: Transient,
- Rigid Body Dynamics
- Explicit/Impact Dynamics
- Rotor Dynamics.
- Mechanism Design.
- Mechanical Vibrations (Modal, Harmonic, and Random Vibration Analysis).

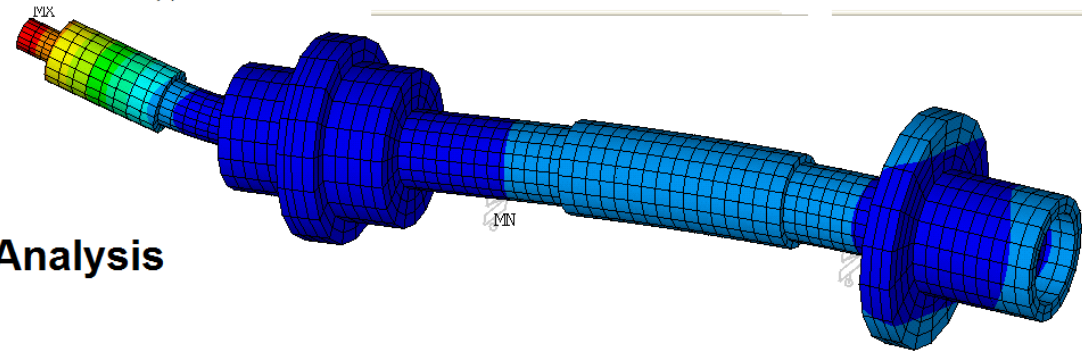
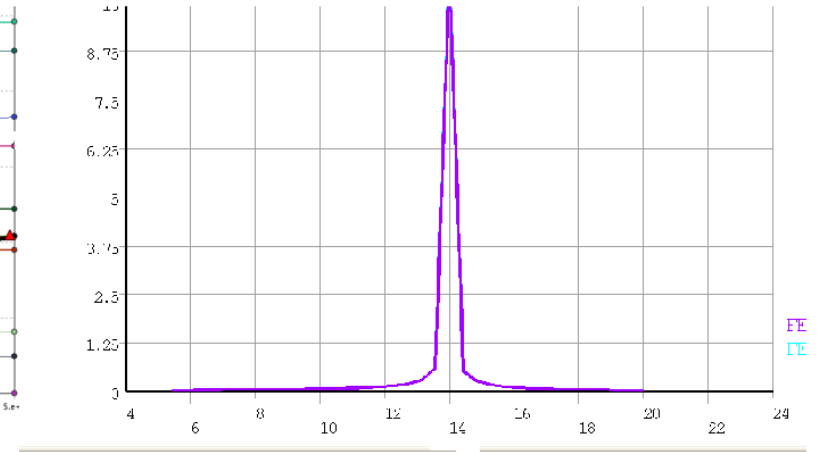
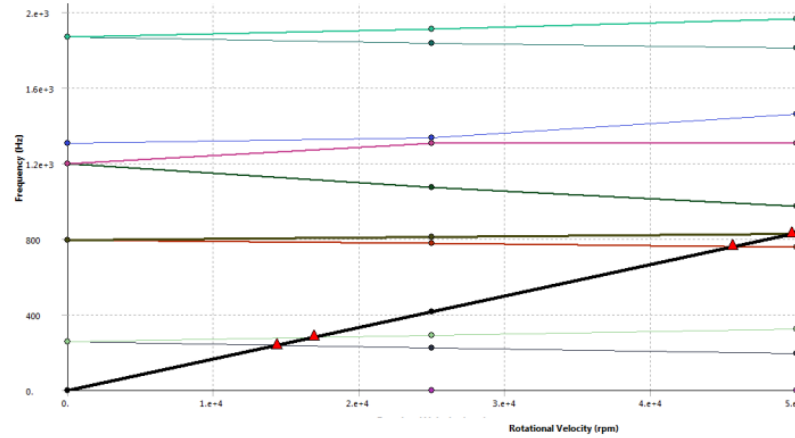

**Rotor Dynamics Analysis**



# Composite Material Structures

Composite Meso-Scale (Laminate Analysis)

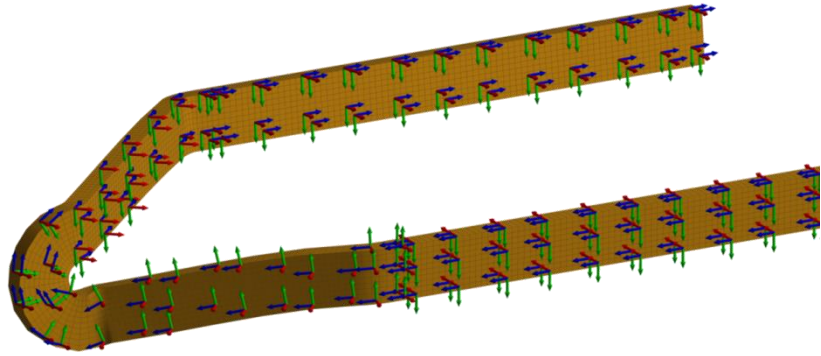

Composite Macro-Scale Analysis

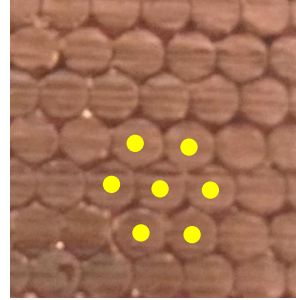
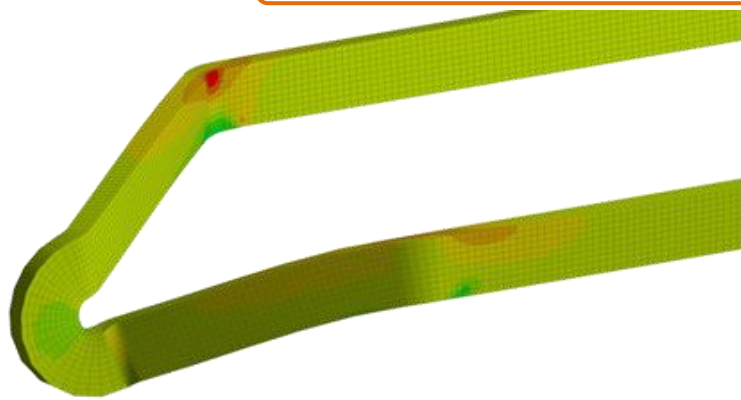

Micro Mechanical Analysis

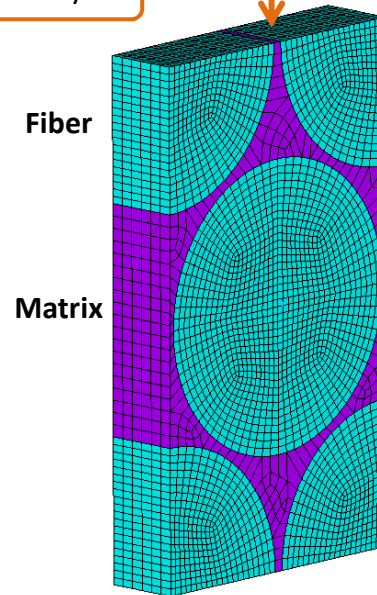
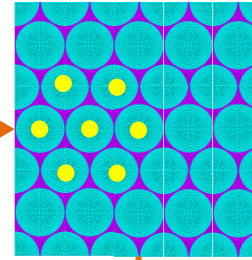

RVE, hexagonal array

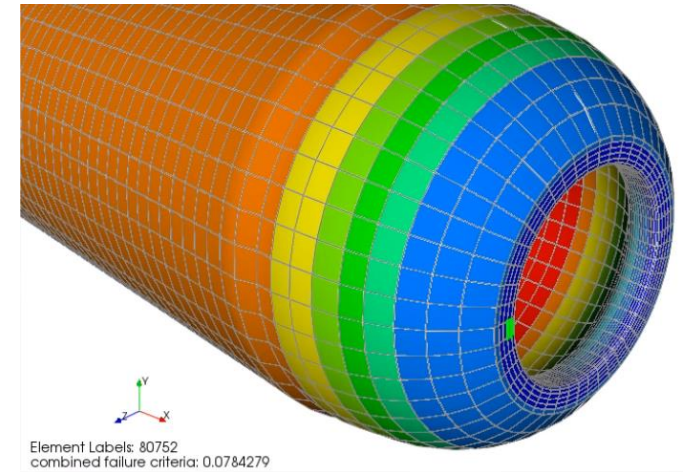
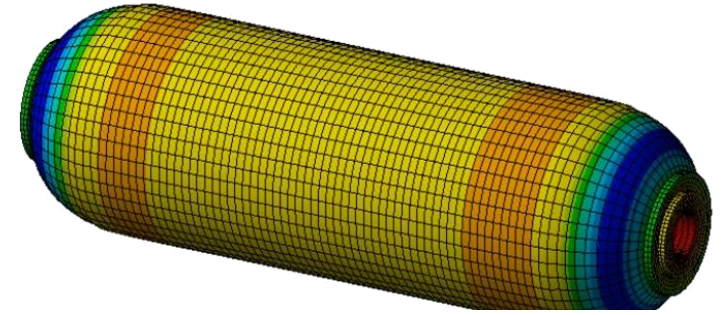

# Analytical Spread Sheet & FEA Tools

We provide full spectrum of numerical simulations, however, not every aspect of real world physics can or should be modeled and numerically computed. On the other hand, physical experiments using test rigs might be needed. In some cases, simple analytical spread sheet models are sufficient for quick design assessment, concept evaluation etc.

- We have developed in house analytical tools for analysis such as bolted joints, gaskets and flanges based on current and established design and analysis methods.
- We also have the capability to link spread sheet tools with finite element analysis using ANSYS APDL. This standardizes analysis and removes any dependence on user skill level. All post processing can be automated.
- Based on your product development needs, we can custom build simple analytical spreadsheet tools for your organization.

## Spread Sheet Tool

Bolt Analysis (UNC)			
Parameter	Value	Unit	Description
d	0.750	in	Bolt Nominal Diameter
TPI	16.00	-	threads per inch
Lc	1.50	in	Clamped Length
Lb	2.5	in	Bolt length
Eb	30E+06	psi	Young's Modulus Bolt Material
Sy	3.60E+04	psi	Bolt Yield Strength
K	0.2		Bolt Torque Constant
p	0.0625	in	Thread Pitch
dm	0.6688	in	minor bolt dia
dp	0.7094	in	bolt pitch dia
dt	0.6891	in	Tensile Dia, Used in FEA
At	0.3730	in^2	Tensile Area "At"
Ab	0.4418	in^2	Nominal cross section area of bolt
Lthd	1.75	in	Thread length upto 6" bolts
Ls	0.75	in	Bolt Shank length
Lt	0.75	in	Thread length in grip
kb	8.089E+06	lb/in	Bolt Stiffness
Sp	3.06E+04	psi	Proof Load
Fi	2.70E+04	lbf	Bolt Preload based on 0.75*Sp
T	337.5	ft-lb	Bolt Torque Constant

Gasket Design for Pressure Vessel			
Parameter	Value	Unit	Description
Gasket Type	1	-	Confined (0) or unconfined (1)
Dpv	4	psi	Internal Dia of Pr Vessel
Df	7.25	in	Outside Flange Dia
Dbc	5.5	in	Bolt Circle Diameter
Pr	1500	psi	Internal pressure
t	0.125	in	Gasket Thickness
nb	8	-	No of bolts around flange
Eg	1.000E+04	psi	Young's Modulus Gasket Material
Ag	3.4790	in^2	Gasket contact Area per Bolt
km	1.05E+07	lb/in	Joint Member Stiffness
kg	1.088E+07	lb/in	Gasket Stiffness
kmc	5.346E+06	lb/in	Combined member Stiffness
C	0.602	-	Joint Stiffness Ratio
P_total	695	lbf	Total Force on End Cap of Pr vessel
P	29	lbf	Applied force per bolted joint

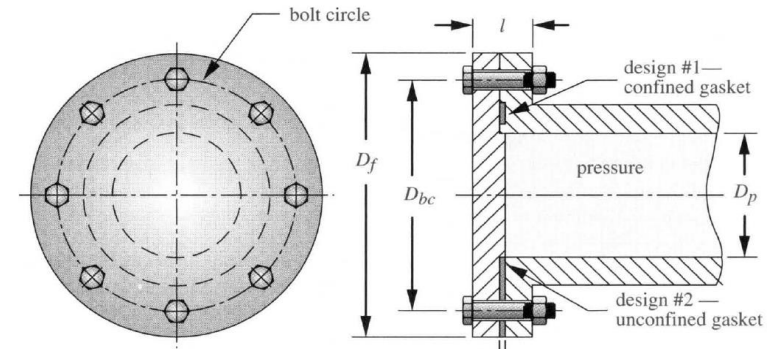

## ANSYS FEA APDL Tool

```

/PMACRO
/clear Database
fint
/clear
jobname = 'rve-0'
/FILNAME,jobname ! Changes jobname

/TITLE, Full Model of RVE, hexagonal array
PI = ACOS(-1) ! calculating pi = 3.14.. for subsequent calculations
*AFUN,DEG !change to degree for all trigonometric calculations

! INPUT GEOMETRY PARAMETERS
!-----
VF = 0.85 ! Fiber volume fraction
df = 1 ! Diameter of fibers in mm
Theta = 60 ! Theta defines geometric distribution of fibers in deg
epo = 0.1 ! Applied Strain: 1 = 100%, 0.1 = 10%, 0.05 = 5%

! INPUT MATERIAL PARAMETERS
!-----
E_f = 138e3 ! Fiber material properties [MPa]
nu_f = 0.343 ! Fiber Poisson's Ratio
rho_f = 8941 ! Fiber Density [kg/m^3]
E_m = 7e3 ! Matrix material properties [MPa]
nu_m = 0.28 ! Matrix Poisson's Ratio
rho_m = 2190 ! Matrix Density [kg/m^3]

MULTIPRO,'START',3 ! Geometric Parameters 3 -> # of parameters
*CSET,1,3,VF,'Fiber volume fraction',VF
*CSET,4,6,df,'Diameter of Fibers',df
*CSET,7,9,Theta,'Hex Angle of Fiber',Theta
*CSET,6,62,'Enter Geometric Parameter Values',, UNIT = 'mm'
*CSET,63,64,'NOTE: There is no error checking, . Check before pressing ok'
MULTIPRO,'END'

MULTIPRO,'START',6 ! Material Parameters 6 -> # of parameters
*CSET,1,3,E_f,'Fiber Modulus',E_f
*CSET,4,6,nu_f,'Fiber Poisson Ratio',nu_f
*CSET,7,9,rho_f,'Fiber Density [kg/m^3]',rho_f
*CSET,10,12,E_m,'Matrix Modulus',E_m
*CSET,13,15,nu_m,'Matrix Poisson Ratio',nu_m
*CSET,16,18,rho_m,'Matrix Density [kg/m^3]',rho_m
    
```





# Computational Fluid Dynamics (CFD)

- Air, ground and sea vehicle lift and Drag.
- Thermal-Fluid systems
- Seals for gas/steam turbine (brush seal, labyrinth seal, honeycomb seal, cloth seal)
- Flow in porous media
- In-cylinder combustion for internal combustion engine
- Hydro, wind turbines
- Heat exchangers

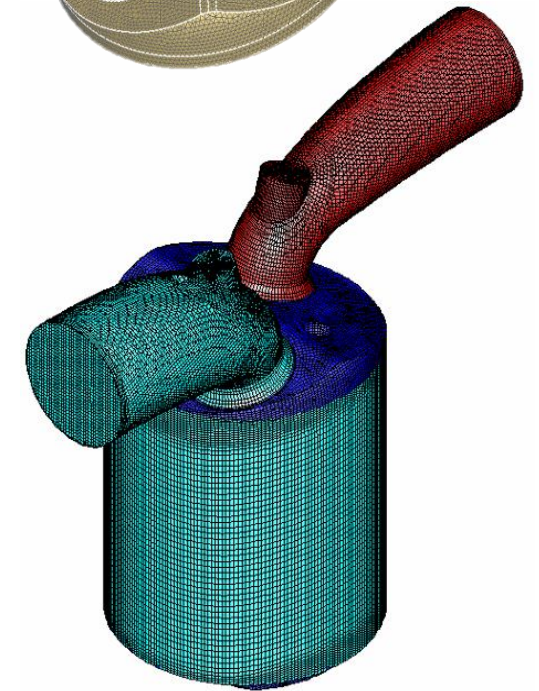
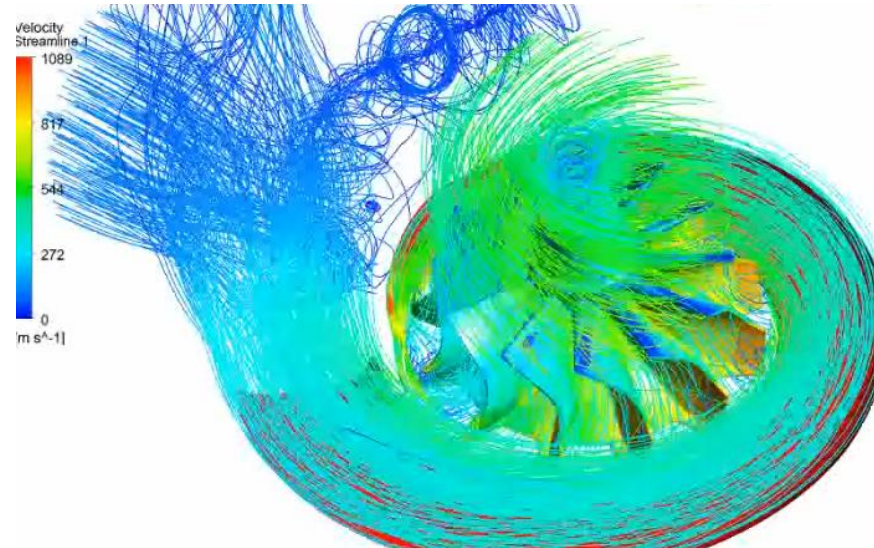
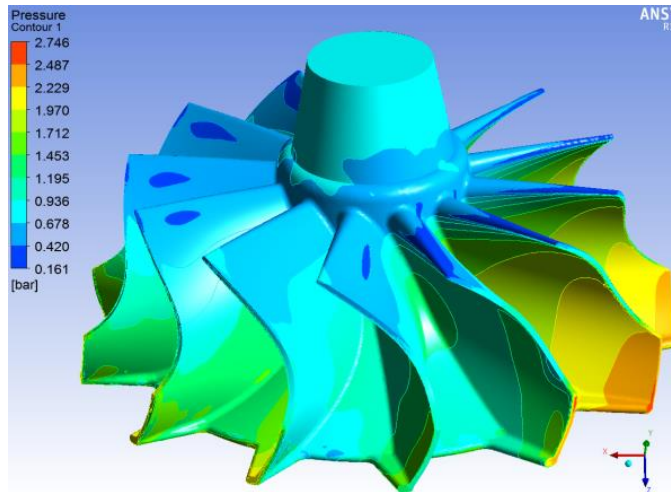
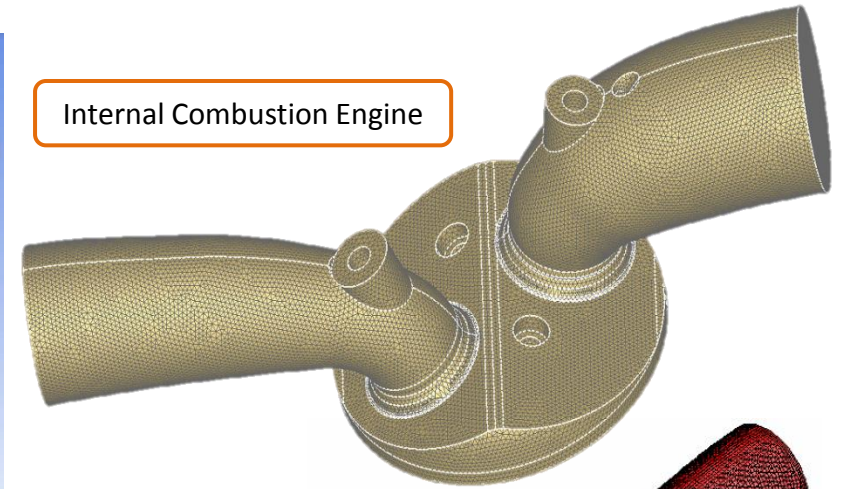
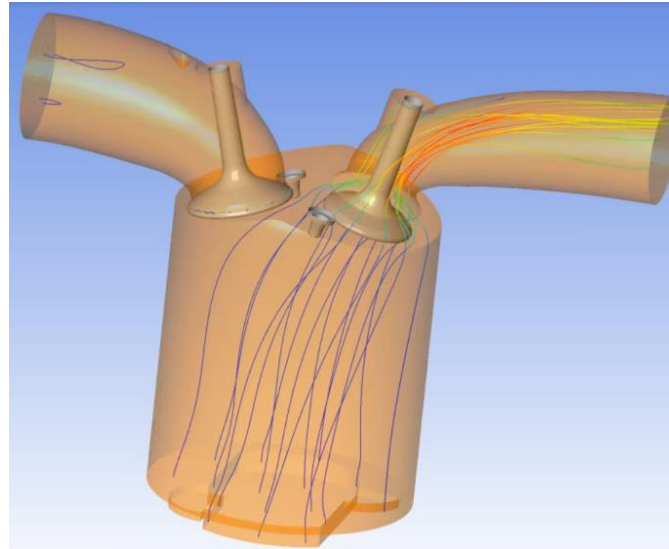



# Computational Fluid Dynamics (CFD)

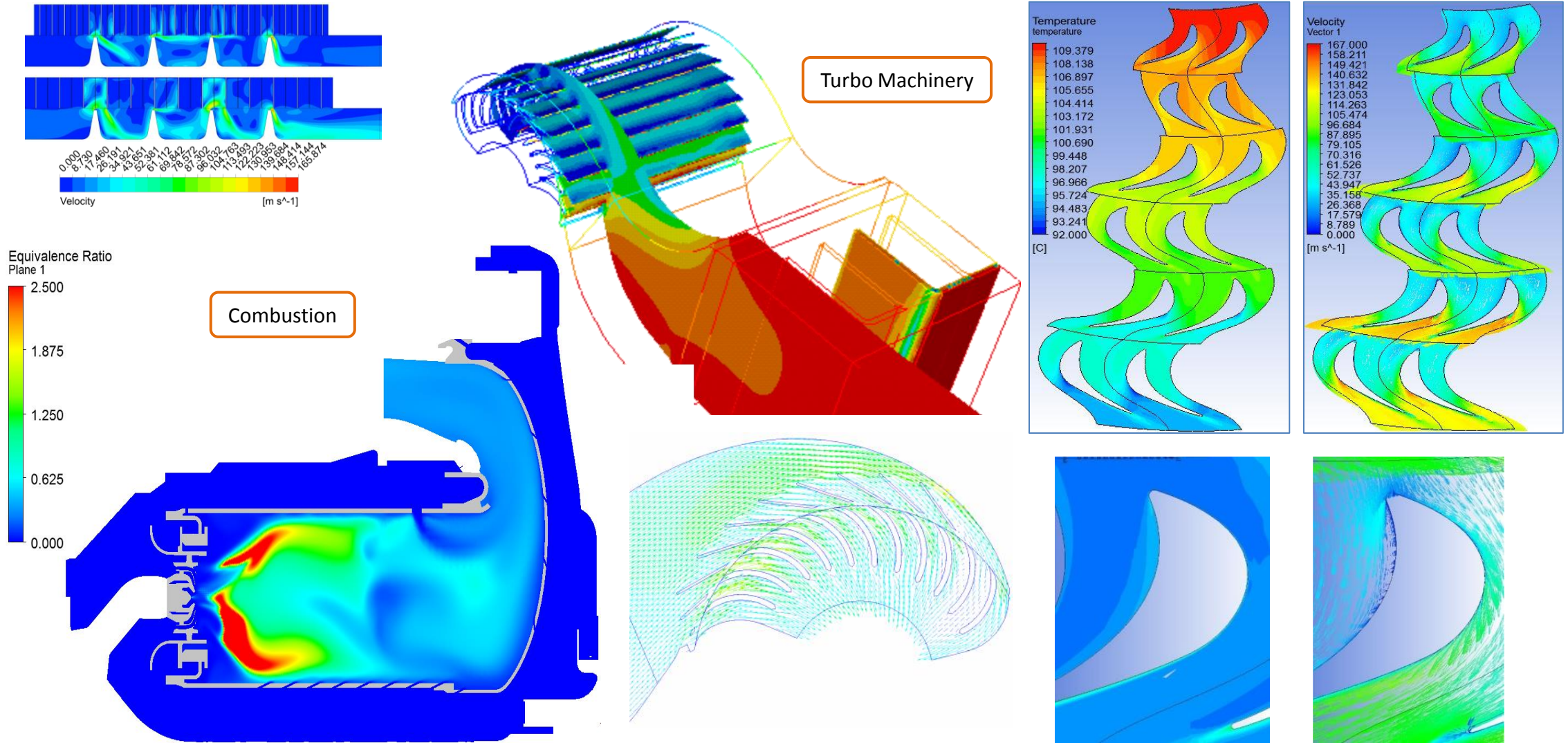

# System Models

- Multi-Domain Lumped Parameter Models based on Matlab & Simulink platforms.
- Simulate effects of dynamic loads on structures e.g. wind, seismic, ocean wave loads.
- System design & performance optimization.

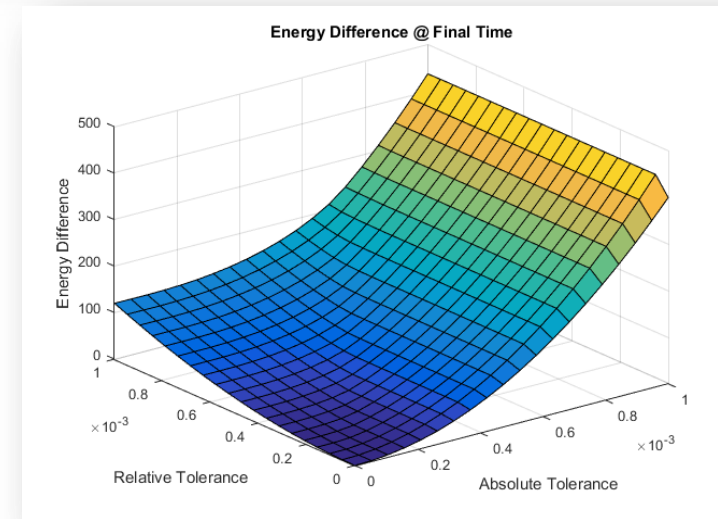
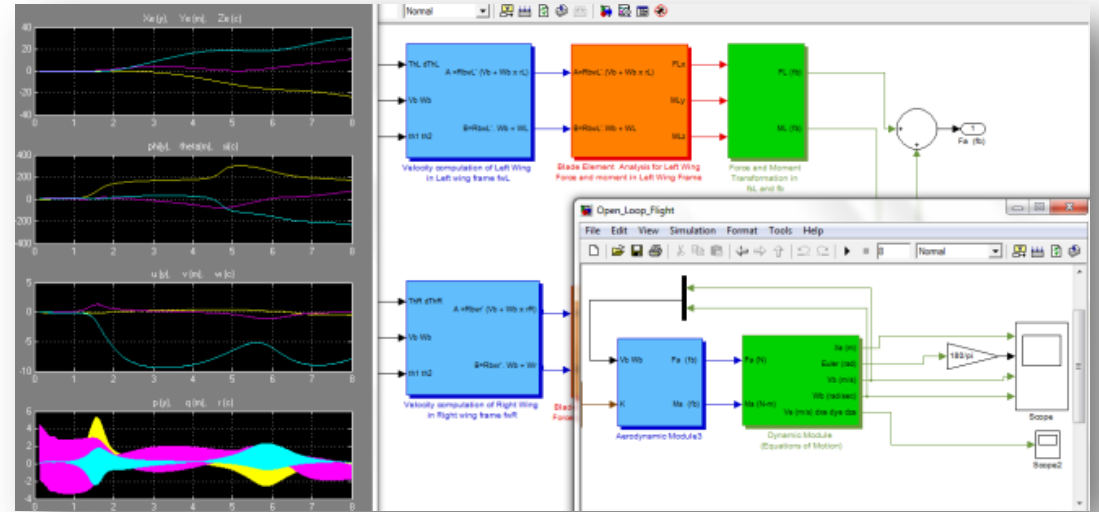
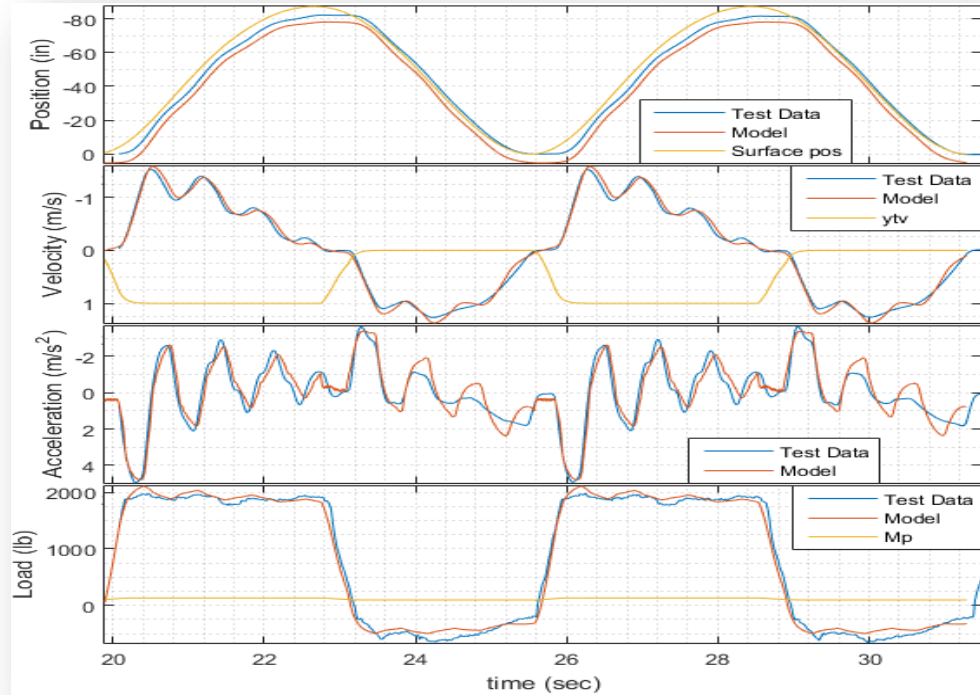

# Robust Design and Design Optimization

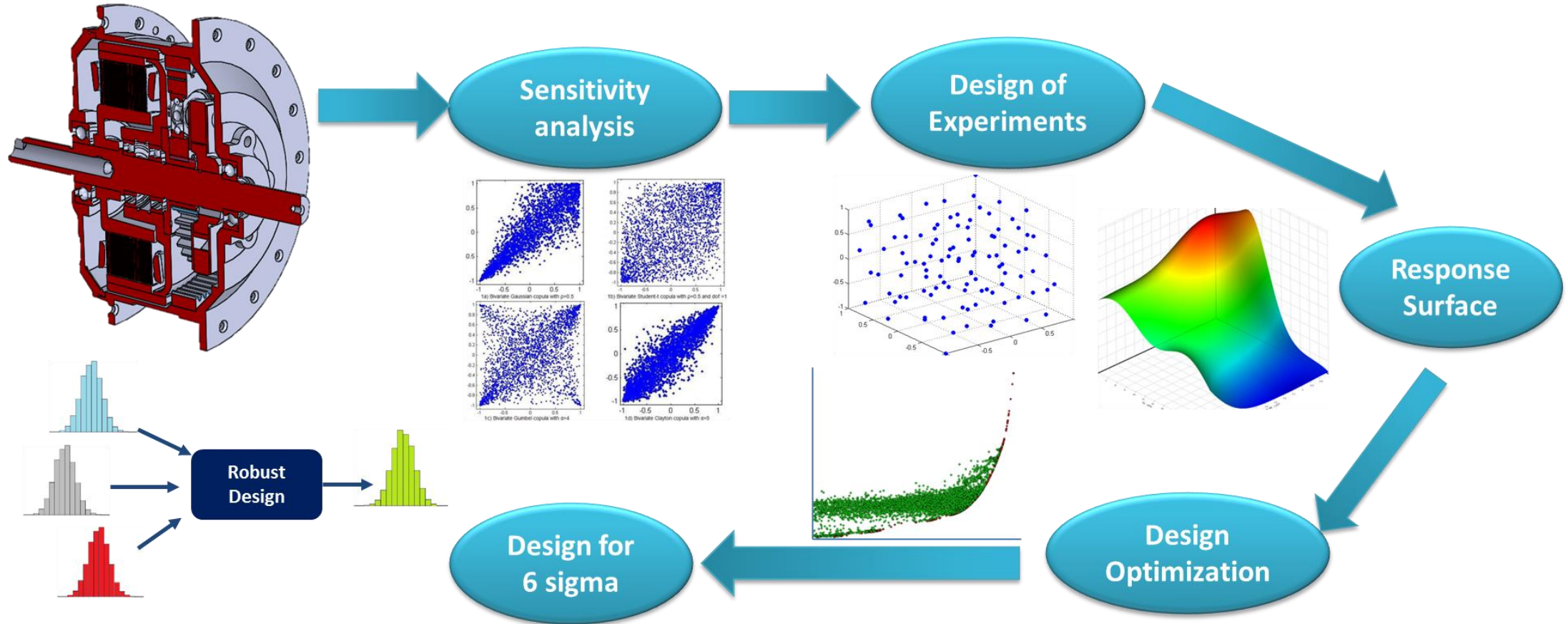



# Test Rig Design, Instrumentation & Controls

Development of Complete Test Rigs

SDM Research & Engineering

GE ROD SEAL GUI

Status: Logging Stopped

Clean Fluid Pressure (psi) 0  
Ambient Fluid Pressure (psi) 0  
Frictional Force (lbf) 500

Ambient Fluid Temp (C) 22.3  
Clean Fluid Temp (C) 0  
Vessel Temp (C) 22.5  
Clean Fluid Leakage (psi) 0

AMT PRECISION MANUFACTURING (518) 877-8560  
Advanced Manufacturing Techniques Inc.

Status: Structural Failure, Test Completed

Force = 3.0 lb  
Displ = 0.203 in

Maximum Force = 26.00 lb  
At Displacement = 0.08 in

Global Max Force 1000 lb

Force Limits: Set Inc Force 10, Set Global Max Force 1000

Repeat Cycle: Enable, Set Cyclic Force 10, Cycles Completed 0, Cycles Required 1



# Engineering Software & Hardware Tools

## Software Tools:

- SolidWorks (CAD/CAM)
- ANSYS (FEA & CFD)
- Matlab (System Models)
- NI LabVIEW (Test Rig instrumentation)

## High Performance Computing:

Xeon Gold 6130, 16 core CPU with 128 GB RAM with SSD storage.

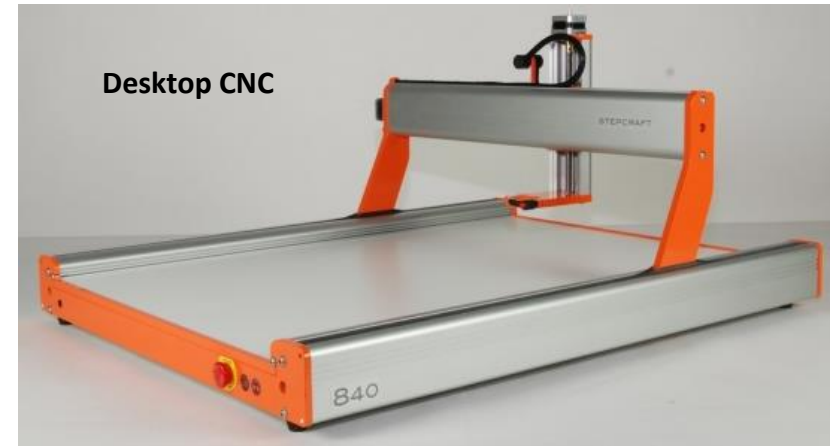

The ANSYS logo, featuring the word 'ANSYS' in a bold, sans-serif font. The 'A' and 'S' are black, while the 'N', 'Y', and 'S' are yellow.

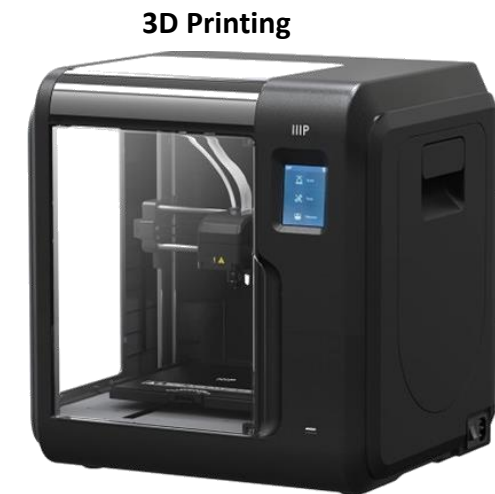

# Machining & Rapid Prototyping



We work closely with Sanken Industry based in Japan for development of prototypes for testing. Sanken offers highest quality of machined components based on their unique in house technology with fast turn around times.

Resin



Resin (Transparency)



Metal



Gears



Resin (Lathe)



Sheet Metal & Bending



Metal (Lathe)



Bending

